

ASSEMBLY INSTRUCTIONS

FOR

2017-2023 CAN AM MAVERICK X3*

*For additional vehicle compatibility, visit www.wilwood.com

**UTV6 FRONT BRAKE KIT
WITH 11.25" DIAMETER
DYNAMIC MOUNT LUG-DRIVE
NON-VENTED ROTORS** OR

**UTV6 FRONT RACE BRAKE
KIT WITH 11.25" DIAMETER
DYNAMIC MOUNT LUG-DRIVE
NON-VENTED ROTORS**

BASE PART NUMBER

140-16628

BASE PART NUMBER

140-17040

**DISC BRAKES SHOULD ONLY BE INSTALLED BY SOMEONE
EXPERIENCED AND COMPETENT IN THE INSTALLATION AND
MAINTENANCE OF DISC BRAKES
READ ALL WARNINGS**

WARNING

IT IS THE RESPONSIBILITY OF THE PERSON INSTALLING ANY BRAKE COMPONENT OR KIT TO DETERMINE THE SUITABILITY OF THE COMPONENT OR KIT FOR THAT PARTICULAR APPLICATION. IF YOU ARE NOT SURE HOW TO SAFELY USE THIS BRAKE COMPONENT OR KIT, YOU SHOULD NOT INSTALL OR USE IT. DO NOT ASSUME ANYTHING. IMPROPERLY INSTALLED OR MAINTAINED BRAKES ARE DANGEROUS. IF YOU ARE NOT SURE, GET HELP OR RETURN THE PRODUCT. YOU MAY OBTAIN ADDITIONAL INFORMATION AND TECHNICAL SUPPORT BY CALLING WILWOOD AT (805) 388-1188, OR VISIT OUR WEB SITE AT WWW.WILWOOD.COM. USE OF WILWOOD TECHNICAL SUPPORT DOES NOT GUARANTEE PROPER INSTALLATION. YOU, OR THE PERSON WHO DOES THE INSTALLATION MUST KNOW HOW TO PROPERLY USE THIS PRODUCT. IT IS NOT POSSIBLE OVER THE PHONE TO UNDERSTAND OR FORESEE ALL THE ISSUES THAT MIGHT ARISE IN YOUR INSTALLATION.

RACING EQUIPMENT AND BRAKES MUST BE MAINTAINED AND SHOULD BE CHECKED REGULARLY FOR FATIGUE, DAMAGE, AND WEAR.



Need Additional Information? Use Your SmartPhone and Jump to Our Technical Tips Section on Our Web Site.

WARNING

**DO NOT OPERATE ANY VEHICLE ON UNTESTED BRAKES!
SEE MINIMUM TEST PROCEDURE WITHIN**

ALWAYS UTILIZE SAFETY RESTRAINT SYSTEMS AND ALL OTHER AVAILABLE SAFETY EQUIPMENT WHILE OPERATING THE VEHICLE

IMPORTANT • READ THE DISCLAIMER OF WARRANTY INCLUDED IN THE KIT

NOTE: Some cleaners may stain or remove the finish on brake system components. Test the cleaner on a hidden portion of the component before general use.

Important Notice - Read This First

Wilwood Disc Brake components and complete brake kits are designed for factory, un-modified vehicles, as a direct bolt-on system with little or no alterations to be made to factory component designs. When adding aftermarket components such as hubs, spindles/uprights, suspension, brake lines and wheels, fitment of the Wilwood components must be verified by the installer through the full range articulation of the suspension. Failure to do so may result in damage to the vehicle and/or the Wilwood Disc Brake kit.

Before any tear-down or disassembly begins, review the following information:

- **Important:** Before assembling this kit, see "Modification Instructions" for information on clearancing the upright for proper caliper mounting on page 4.
- Review the wheel clearance diagram (figure 2, page 3) to verify that there is adequate clearance with the wheels you will be using with the installation.
- This brake kit does not include flexlines.
- Due to OEM production differences and other variations from vehicle to vehicle, the fastener hardware and other components in this kit may not be suitable for a specific application or vehicle.
- It is the responsibility of the purchaser and installer of this kit to verify suitability / fitment of all components and ensure all fasteners and hardware achieve complete and proper engagement. Improper or inadequate engagement can lead to component failure.

Exploded Assembly Diagram

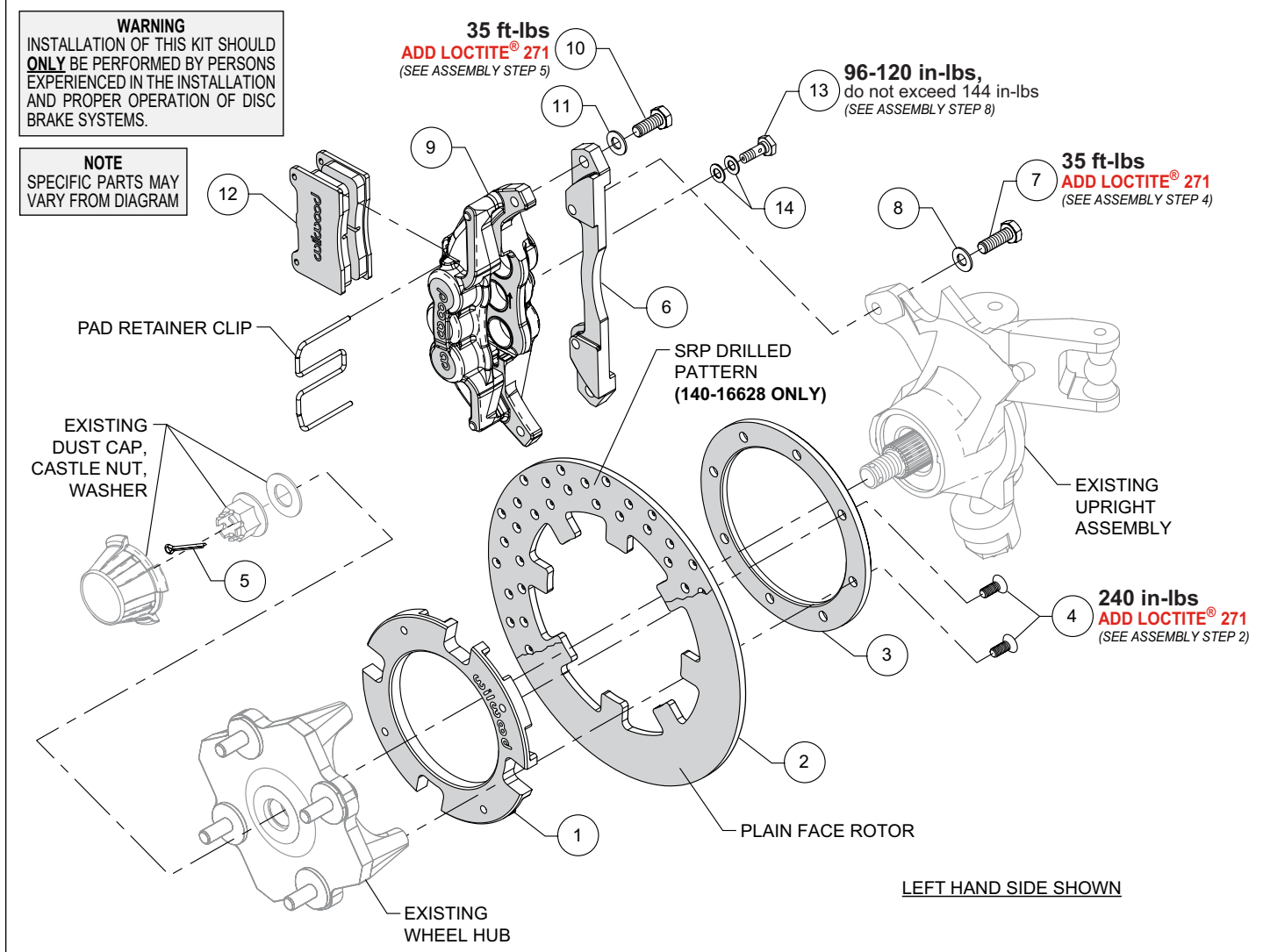

Figure 1. Typical Installation Configuration

Parts List

ITEM NO.	PART NO.	DESCRIPTION	QTY
1	300-16588	Adapter, Rotor, 4 x 6.30" Bolt Circle	2
2	160-16515	Rotor, .25" Thk x 11.25" Diameter, Dynamic Mount, 8-Lug	2
2A	160-16979	Rotor, SRP Drilled	2
3	300-16589	Adapter, Ring, 4 x 6.30" Bolt Circle	2
4	230-16773	Bolt, M8-1.25 x 20mm, Flat Head	16
5	180-15902	Cotter Pin	2
6	250-16592	Bracket, Caliper Mounting	2
7	230-10954	Bolt, M10-1.50 x 30mm, Hex Head	4
8	240-17663	Washer, 10mm I.D. x 18mm O.D. x 1.6mm Thick	4
9	120-16566/67-BK	Caliper, UTV6, Black, (one each, right & left), included with p/n 140-16628	2
9	120-16566/67	Caliper, UTV6, Anodized, (one each, right & left), included with p/n 140-17040	2
9A	120-16566/67-RD	Caliper, UTV6, Red, (one each, right & left)	2
10	230-12856	Bolt, M10-1.50 x 25mm, Hex Head	4
11	240-17663	Washer, 10mm I.D. x 18mm O.D. x 1.6mm Thick	4
12	150-9136K	Pad, BP-10 Compound, Axle Set, included with p/n 140-16628	1
12	15E-9837K	Pad, PolyMatrix, Compound E, Axle Set, included with p/n 140-17040	1
13	230-16715	Bolt, Banjo, M10-1.25 x 20mm	2
14	240-5227	Washer, Copper, Crush, .406" I.D. x .625" O.D. x .063" Thick	4

NOTES:

Part Number 230-10964 Bracket Mounting Bolt Kit, includes part numbers 230-10954 and 240-17663

Part Number 230-16721 Rotor Adapter Bolt Kit, includes part number 230-16773

Part Number 230-16777 Caliper Mounting Bolt Kit, includes part numbers 230-12856 and 240-17663

Item 2A is an optional item for kit **140-16628 only** and is included in the "-D" drilled rotor kits. Add "-D" to end of kit part number when ordering

Item 9A is an optional item for kit **140-16628 only** and is included with the "-R" red caliper kits. Add "-R" to the end of the part number when ordering

Photographic Tip

Important and highly recommended: Take photos of brake system before disassembly and during the disassembly process. In the event, trouble-shooting photos can be life savers. Many vehicles have undocumented variations, photos will make it much simpler for Wilwood to assist you if you have a problem.

General Information

•Installation of this kit should **ONLY** be performed by persons experienced in the installation and proper operation of disc brake systems. Before assembling this Wilwood disc brake kit, double check the following to ensure a trouble free installation.

•Inspect the contents of this kit against the parts list to ensure that all components and hardware are included.

•Make sure this is the correct kit to fit the exact make and model year of your vehicle. This front kit is designed for direct bolt-on installation to 2017- 2023 model year Can Am Maverick X3 UTV.

•Verify your wheel clearance using Figure 2.

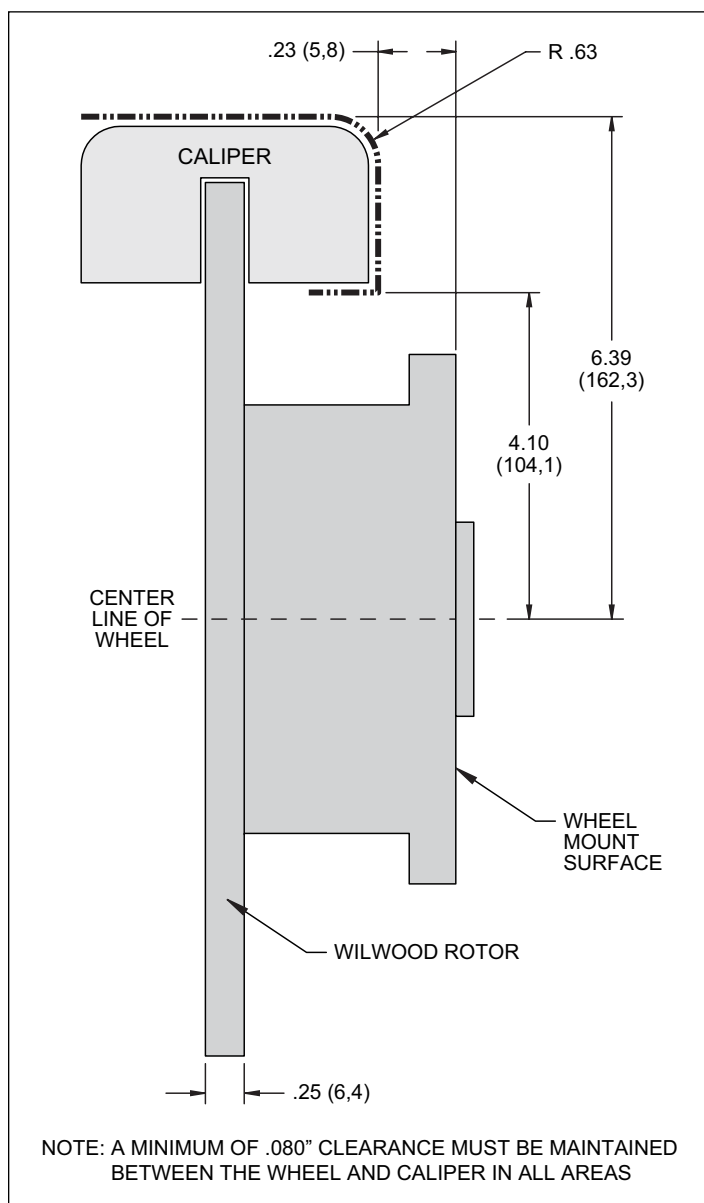

Figure 2. Wheel Clearance Diagram

Disassembly Instructions

- Disassemble the original equipment front brakes:

Raise the front wheels off the ground and support the front suspension according to the vehicle manufacturer's instructions.

Remove the front wheels, calipers, wheel hubs, and rotors.

- Remove any nicks or burrs on the wheel hub and upright that may interfere with the installation of the new brake components.

- Clean and de-grease the wheel hub, and upright.

Modification Instructions

•**NOTE:** Some grinding of the casting line on the outer edge of lower caliper mounting tab of upright may be required for proper fitment of new caliper. If necessary, only grind off enough material to provide adequate clearance so that the Wilwood caliper does not touch the mounting tab and properly attaches to caliper mounting bracket without any binding, see Photos A and B at right.



Photo A

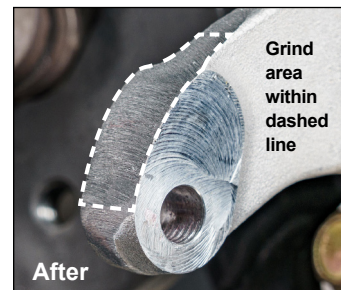

Photo B

Assembly Instructions



Photo 1



Photo 2

NOTE: Numbers in parenthesis refer to the parts list and Figure 1 on the preceding pages.

STEP 1 Place the existing OEM wheel hub face down and position the rotor adapter (1) onto the wheel hub as shown in Figure 1 and Photo 1. **NOTE:** The existing wheel hub must be free of dirt and debris or excessive rotor run out may result.

STEP 2 Position the rotor (2) onto the rotor adapter (1), making sure the rotor lugs fit into the recesses of the rotor adapter, as shown in Photo 2. Place the adapter ring (3) onto the assembly and attach using bolts (4), Photos 3 and 4. Using an alternating sequence, apply red *Loctite*® 271 to the threads, and torque to value shown in Figure 1.



Photo 3



Photo 4

STEP 3 Grease the splines and outer snout of the existing wheel hub and slide the wheel hub/rotor assembly onto the axle and attach using the existing OEM washer and castle nut. Tighten to OEM specifications and secure using cotter pin (5), Photo 5. Reinstall the existing dust cap, Photo 6.

STEP 4 Orient the caliper mounting bracket (6), as shown in Figure 1 and Photo 7. Install using bolts (7) and washers (8). Apply red *Loctite*® 271 to the bolt threads and torque to value shown in Figure 1.

Assembly Instructions (Continued)



Photo 5



Photo 7

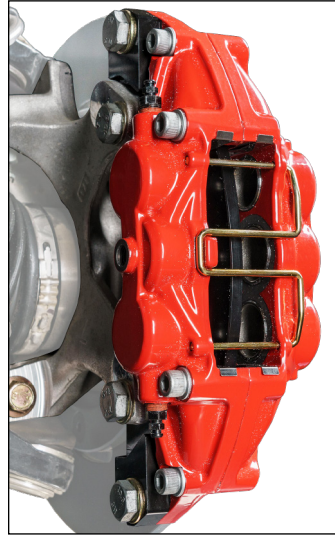

Photo 8

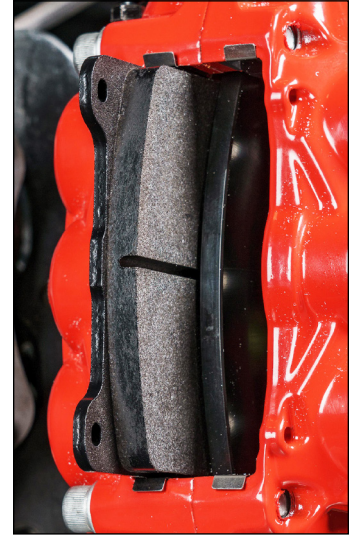

Photo 9



Photo 6

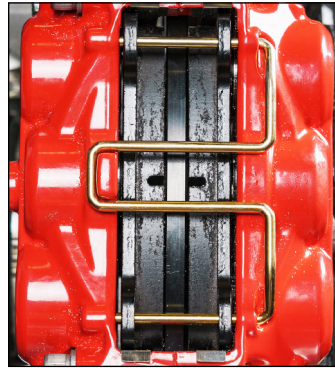

Photo 10

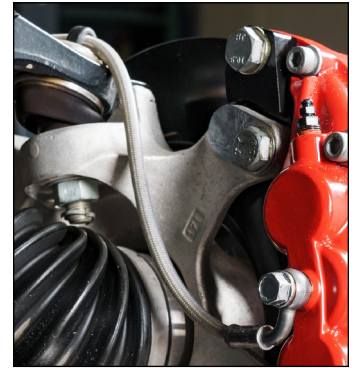

Photo 11

STEP 5 Secure the caliper (9) to the mounting bracket (6) using bolts (10) and washers (11), as shown in Figure 1 and Photo 8. Apply red *Loctite*® 271 to the threads, and torque to value shown in Figure 1.

STEP 6 Remove the pad retainer clip from the caliper (9). Insert the brake pads into the caliper with the friction material facing the rotor, as shown in Photo 9. Reinstall the pad retainer clip, Photo 10.

STEP 7 Temporarily install the wheel and torque the lug nuts to the manufacturer's specification. Ensure that the wheel rotates freely without any interference. Remove wheel for next step.

STEP 8 Attach brake line to caliper. Orient OEM brake line as shown in Photo 11 and connect to caliper using banjo bolt (13) and crush washers (14). Do not use lubricant or thread sealant on banjo bolt (13). Torque to minimum value shown in Figure 1. Check for leakage, increasing torque only to stop leakage without exceeding maximum specification. Replace crush washers and banjo bolt whenever reassembly is required. **Ensure hoses are routed to prevent contact with moving suspension, brake or wheel components.**

•NOTE: The caliper in this brake kit utilizes a 10mm x 1.25 thread inlet, the same as the Original Equipment Manufacturer (OEM) caliper.

•CAUTION: In absence of specific instructions for brake line routing, the installer must use his best professional judgment on correct routing and retention of lines to ensure safe operation. It is the installer's responsibility to properly route and provide adequate clearance and retention for brake hose components.

It is also the installer's responsibility to ensure that all fittings and hoses are the correct size and length, properly seal, and that they will not be subject to crimping, strain and abrasion from vibration or interference with suspension components, brake rotor or wheel.

STEP 9 Bleed the brake system, referring to the 'Additional Information and Recommendations' on page 6 for proper bleeding instructions. Check system for leaks after bleeding.

STEP 10 Install the wheel and torque the lug nuts to manufacturer's specifications.

•CAUTION: Test vehicle brake system per the 'Minimum Test Procedure' stated within this document before driving. After road testing, inspect for leaks and interference. Initially after install and testing, perform frequent checks of the vehicle brake system and lines before driving, to confirm that there is no undue wear or interference not apparent from the initial test. Afterwards, perform periodic inspections for function, leaks and wear in a interval relative to the usage of vehicle.

STEP 11 Bed-in the brake pads per the procedure on page 7.

Additional Information and Recommendations

•First, reference the manufacturer's service manual for the proper flushing and bleeding procedures for your vehicle, and then consult the additional information and recommendations below for proper bleeding instructions.

•Please read the following concerning balancing the brake bias on 4 wheel disc vehicles.

This Can Am Maverick X3 kit can be operated using the stock OEM master cylinder. However, as with most suspension and tire modifications (from OEM specifications), changing the brakes may alter the front to rear brake bias. Rear brakes should not lock up before the front. Brake system evaluation and tests should be performed by persons experienced in the installation and proper operation of brake systems. Evaluation and tests should be performed under controlled conditions. Start by making several stops from low speeds then gradually work up to higher speeds. Always utilize safety restraint systems while operating vehicle.

•For optimum performance, fill and bleed the new system with Wilwood Hi-Temp° 570 grade fluid, EXP 600 Plus, or XR Race-Only brake fluid. For severe braking or sustained high heat operation, use Wilwood EXP 600 Plus Racing Brake Fluid. For extreme braking temperatures of endurance racing, use Wilwood XR Race-Only Brake Fluid (not DOT approved, off-highway use only). Used fluid must be completely flushed from the system to prevent contamination. **NOTE: Silicone DOT 5 brake fluid is *NOT* recommended for racing or performance driving.**

•To properly bleed the brake system, begin with the caliper farthest from the master cylinder. Bleed the outboard bleed screw first, then the inboard. Repeat the procedure until all calipers in the system are bled, ending with the caliper closest to the master cylinder. **NOTE: When using a new master cylinder, it is important to bench bleed the master cylinder first.**

•Test the brake pedal. It should be firm, not spongy and stop at least 1 inch from the floor under heavy load.

If the brake pedal is spongy, bleed the system again.

If the brake pedal is initially firm, but then sinks to the floor, check the system for fluid leaks. Correct the leaks (if applicable) and then bleed the system again.

If the brake pedal goes to the floor and continued bleeding of the system does not correct the problem, a master cylinder with increased capacity (larger bore diameter) may be required. Wilwood offers various lightweight master cylinders with large fluid displacement capacities.

•**NOTE: With the installation of after market disc brakes, the wheel track may change depending on the application. Check your wheel offset before final assembly.**

Brake Testing

WARNING • DO NOT DRIVE ON UNTESTED BRAKES BRAKES MUST BE TESTED AFTER INSTALLATION OR MAINTENANCE MINIMUM TEST PROCEDURE

- Make sure pedal is firm: Hold firm pressure on pedal for several minutes, it should remain in position without sinking. If pedal sinks toward floor, check system for fluid leaks. **DO NOT** drive vehicle if pedal does not stay firm or can be pushed to the floor with normal pressure.
- At very low speed (2-5 mph) apply brakes hard several times while turning steering from full left to full right, repeat several times. Remove the wheels and check that components are not touching, rubbing, or leaking.
- Carefully examine all brake components, brake lines, and fittings for leaks and interference.
- Make sure there is no interference with wheels or suspension components.
- Drive vehicle at low speed (15-20 mph) making moderate and hard stops. Brakes should feel normal and positive. Again check for leaks and interference.
- Always test vehicle in a safe place where there is no danger to (or from) other people or vehicles.
- Always wear seat belts and make use of all safety equipment.

Pad and Rotor Bedding

BEDDING STEPS FOR NEW PADS AND ROTORS – ALL COMPOUNDS

Once the brake system has been tested and determined safe to operate the vehicle, follow these steps for the bedding of all new pad materials and rotors. These procedures should only be performed on a race track, or other safe location where you can safely and legally obtain speeds up to 65 MPH, while also being able to rapidly decelerate.

- Begin with a series of light decelerations to gradually build some heat in the brakes. Use an on-and-off the pedal technique by applying the brakes for 3-5 seconds, and then allow them to fully release for a period roughly twice as long as the deceleration cycle. If you use a 5 count during the deceleration interval, use a 10 count during the release to allow the heat to sink into the pads and rotors.
- After several cycles of light stops to begin warming the brakes, proceed with a series of medium to firm deceleration stops to continue raising the temperature level in the brakes.
- Finish the bedding cycle with a series of 8-10 hard decelerations from 55-65 MPH down to 25 MPH while allowing a proportionate release and heat-sinking interval between each stop. The pads should now be providing positive and consistent response.
- If any amount of brake fade is observed during the bed-in cycle, immediately begin the cool down cycle.
- Drive at a moderate cruising speed, with the least amount of brake contact possible, until most of the heat has dissipated from the brakes. Avoid sitting stopped with the brake pedal depressed to hold the car in place during this time. Park the vehicle and allow the brakes to cool to ambient air temperature.

COMPETITION VEHICLES

- If your race car is equipped with brake cooling ducts, blocking them will allow the pads and rotors to warm up quicker and speed up the bedding process.
- Temperature indicating paint on the rotor and pad edges can provide valuable data regarding observed temperatures during the bedding process and subsequent on-track sessions. This information can be highly beneficial when evaluating pad compounds and cooling efficiencies.

POST-BEDDING INSPECTION – ALL VEHICLES

- After the bedding cycle, the rotors should exhibit a uniformly burnished finish across the entire contact face. Any surface irregularities that appear as smearing or splotching on the rotor faces can be an indication that the brakes were brought up to temperature too quickly during the bedding cycle. If the smear doesn't blend away after the next run-in cycle, or if chatter under braking results, sanding or resurfacing the rotors will be required to restore a uniform surface for pad contact.

PRE-RACE WARM UP

- Always make every effort to get heat into the brakes prior to each event. Use an on-and-off the pedal practice to warm the brakes during the trip to the staging zone, during parade laps before the flag drops, and every other opportunity in an effort to build heat in the pads and rotors. This will help to ensure best consistency, performance, and durability from your brakes.

DYNO BEDDED COMPETITION PADS AND ROTORS

- Getting track time for a proper pad and rotor bedding session can be difficult. Wilwood offers factory dyno-bedded pads and rotors on many of our popular competition pads and **Spec 37** GT series rotors. Dyno-bedded parts are ready to race on their first warm up cycle. This can save valuable time and effort when on-track time is either too valuable or not available at all, Dyno-bedding assures that your pads and rotors have been properly run-in and are ready to go. Contact your dealer or the factory for more information on Wilwood Dyno-Bedding services.

NOTE: NEVER allow the contact surfaces of the pads or rotors to be contaminated with brake fluid. Always use a catch bottle with a hose to prevent fluid spill during all brake bleeding procedures.

Connect with Wilwood

Wilwood Facebook 

Wilwood Instagram 

Wilwood Twitter 

Wilwood YouTube 

Associated Components

<u>PART NO.</u>	<u>DESCRIPTION</u>
290-0632	Wilwood Racing Brake Fluid (Hi-Temp° 570) (12 oz)
290-6209	Wilwood Racing Brake Fluid (EXP 600 Plus) (16.9 oz)
260-16018	Wilwood Brake Bleed Bottle, with Tubing
260-0627	Wilwood Bleed Screw Kit, 1/8-27 Fitting Size, 4 Pack
150-9136K	BP-10 Performance Racing Brake Pads • Baseline Pad for Track Oriented UTVs
15E-9837K	PolyMatrix, Compound E Performance Racing Brake Pads
300-16565	Brake Pad Retainer Clip
300-10828	Caliper Wear Plate, Stainless, Right Hand
300-10829	Caliper Wear Plate, Stainless, Left Hand